



Rapid Shelf Installation Open to Open Mount

© 2020 Rubbermaid Incorporated,
8935 NorthPointe Executive Park Dr.
Huntersville, NC, 28078-1801 U.S.A.

www.rubbermaid.com

1-888-895-2110 US | 1-866-595-0525

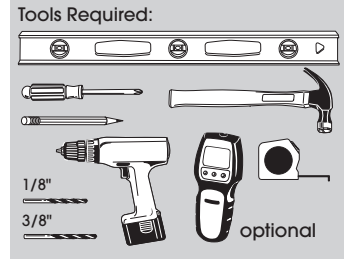
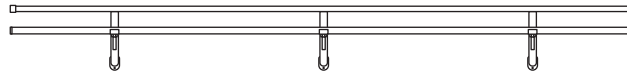

Please check that you have all parts before beginning and follow the instructions carefully.

	Letter	Part Number	Description
	A	2143683	Screw, #10 x 2" Wood Screw
	B	2143684	Screw, #10 x 3/4" Wood Screw
	C	2143681	Drywall Anchor
	D	2125613 - Black 2125611 - SNCKL 2125618 - White	Back Channel
	E	2125600 - Black 2125605 - SNCKL 2125608 - White	Angle Bracket
	F	2125634 - Black 2125633 - SNCKL 2125636 - White	Corner H-Channel
	G	2125638 - Black 2125632 - SNCKL 2125635 - White	Straight H-Channel
	H	2125631 - Black 2125620 - SNCKL 2125637 - White	Shelf End Cap
	I	2125603 - Chrome	Corner Rounded Hang Bar
	J	FG3E55S1CHERY - Cherry FG3E55S1IVORY - Ivory FG3E55S1MAHOG - Mahogany FG3E55S1WHT - White 2044403 - Gray	Melamine Board - 96" x 14" x 0.75"
	K	2125610 - Chrome	Hang Rod Cap
	L	2125602 - Black 2125599 - SNCKL 2125616 - White	Angle Bracket With Hook
	M	2125604	Hang Rod Joiner
	N	2125617 - Chrome	Hang Rod - 96" x 1" OD

Note: Use 1/8" drill bit for screw (A) and 3/8" drill for drywall anchor (C) to drill pilot holes prior to installing.

STEP 1

Determine desired shelf length and cut back channel (D) 1" shorter. Mark desired height, then locate and mark studs near the ends of the channel. Drill pilot holes if necessary. Using a level and #2 Phillips drill bit, secure back channel on either end with a screw (A). Place a screw every 16" from first screw into stud. If drywall mounting place screw (A) plus drywall anchor (C) no more than 12" apart.

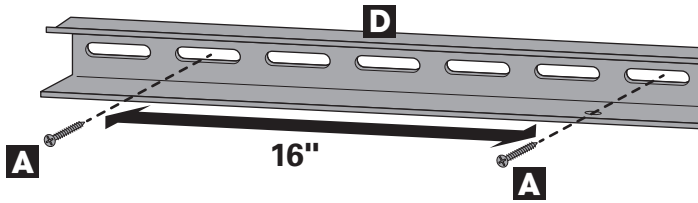

STEP 2

Measure and cut melamine board (J) to desired length of shelf (as determined in Step 1). Rest board on lower lip of back channel and slide backwards leaving 1/2" of board outside back channel on either end. Push in firmly to ensure board makes contact with back surface. Secure board from underside with screw (B) where applicable.

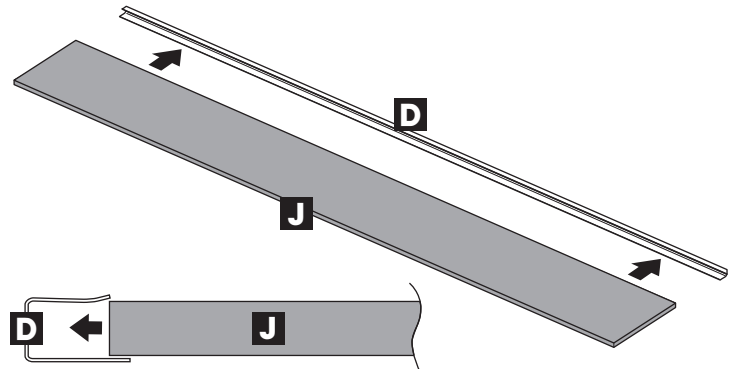

Bottom View

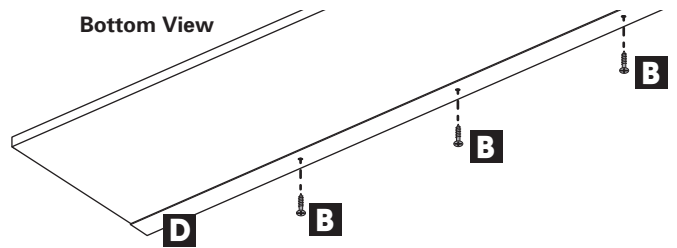

STEP 3

Place angle brackets (E) symmetrically under melamine board (J), no more than 32" apart and no more than 6" from each end, into studs. If stud not available use drywall anchor (C) and place brackets no more than 24" apart. If installing hang rod use angle bracket with hook (L). Place level on top of shelf during installation and adjust angle brackets accordingly. Drill keyhole 7" down from bottom of board. Screw in (A) until threads are no longer visible. Place screw in keyhole and press angle bracket down to engage. Use screw (A) for wall and screw (B) for board. If stud not available use drywall anchor (C) when screwing into wall.

Front View

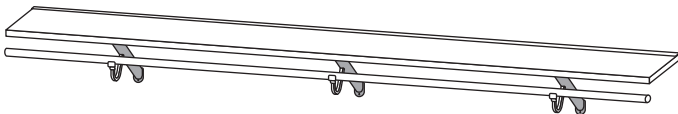

Wall Side View

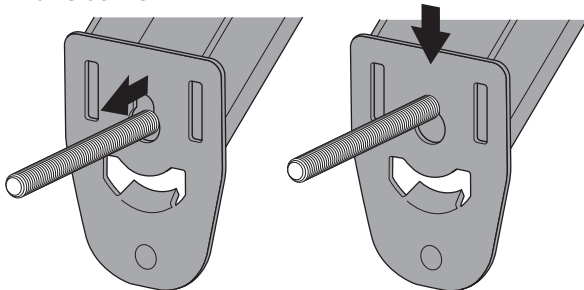

STEP 4

Place shelf end cap (H) on either end of board and press in firmly until secure.

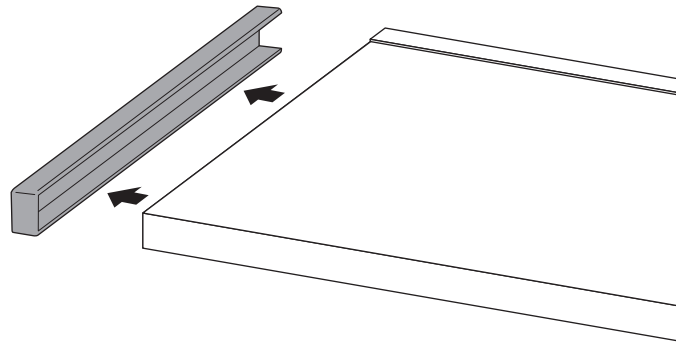

ADDITIONAL INFORMATION

When desired shelf length exceeds 8':

- Use straight H-Channel (G) where end of melamine boards (J) meet to conceal gap

When joining boards in a corner between two walls:

- Use corner H-Channel (F) where melamine boards (J) meet to conceal gap

If using hang rod:

- Combine multiple hang rods (N) using hang rod joiner (M). Insert into both poles and screw until tight
- A hang rod end cap (K) should be used on hang rods (N) used on open ended shelves
- Corner rounded hang bar (I) should be used when combining pole sections at a corner



Rapid Shelf Installation Wall to Wall Mount







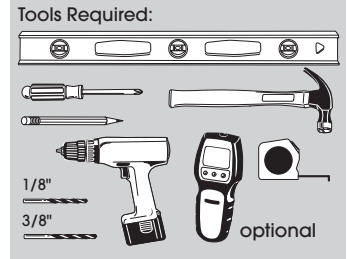
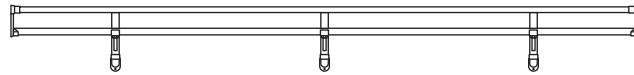



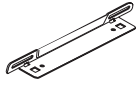

© 2020 Rubbermaid Incorporated,
8935 NorthPointe Executive Park Dr.
Huntersville, NC, 28078-1801 U.S.A.

www.rubbermaid.com

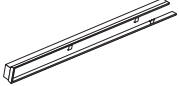
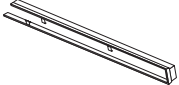
1-888-895-2110 US | 1-866-595-0525

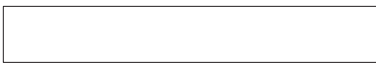

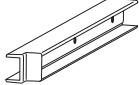
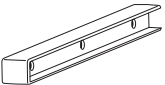
Please check that you have all parts before beginning and follow the instructions carefully.

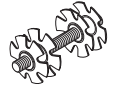
	Letter	Part Number	Description
	A	2143683	Screw, #10 x 2" Wood Screw
	B	2143684	Screw, #10 x 3/4" Wood Screw
	C	2143681	Drywall Anchor
	D	2125613 - Black 2125611 - SNCKL 2125618 - White	Back Channel
	E	2125601	Side Bracket
	F	2125600 - Black 2125605 - SNCKL 2125608 - White	Angle Bracket
	G	2125606 - Black 2125612 - SNCKL 2125609 - White	Shelf Trim Left
	H	2125615 - Black 2125612 - SNCKL 2125607 - White	Shelf Trim Right
	I	2125614	Pole Cup
	J	2125617 - Chrome	Hang Rod
	K	FG3E55S1CHERY - Cherry FG3E55S1IVORY - Ivory FG3E55S1MAHOG - Mahogany FG3E55S1WHT - White 2044403 - Gray	Melamine Board
	L	2125602 - Black 2125599 - SNCKL 2125616 - White	Angle Bracket with Hook
	M	2125634 - Black 2125633 - SNCKL 2125636 - White	Corner H-Channel
	N	2125638 - Black 2125632 - SNCKL 2125635 - White	Straight H-Channel
	O	2125603 - Chrome	Corner Rounded Hang Bar
	P	2125604	Hang Rod Joiner

Note: Use 1/8" drill bit for screw (A) and 3/8" drill for drywall anchor (C) to drill pilot holes prior to installing.

STEP 1

Measure wall from corner to corner and cut back channel (D) to same width. Mark desired height, then locate and mark studs near the ends of the channel. Drill pilot holes if necessary. Using a level and #2 Phillips drill bit secure back channel on either end with a screw (A). Place a screw every 16" from first screw into stud. If drywall mounting place screw (A) plus drywall anchor (C) no more than 12" apart.

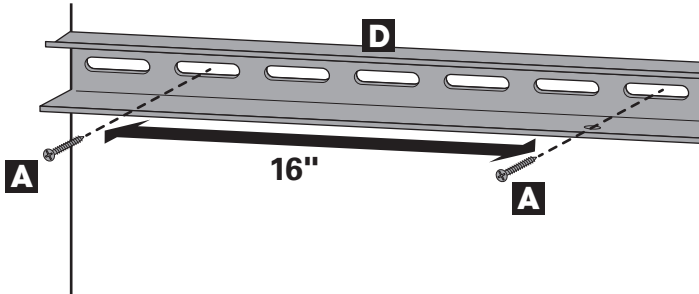

STEP 2

Install side brackets (E) on either end of back channel (D) using a level. Ensure that the flange of the side bracket (E) is flush with rear surface of back channel as shown. Secure into stud if possible using (2) of screw (A) for each bracket. If stud not available use drywall anchor (C) plus screw (A).

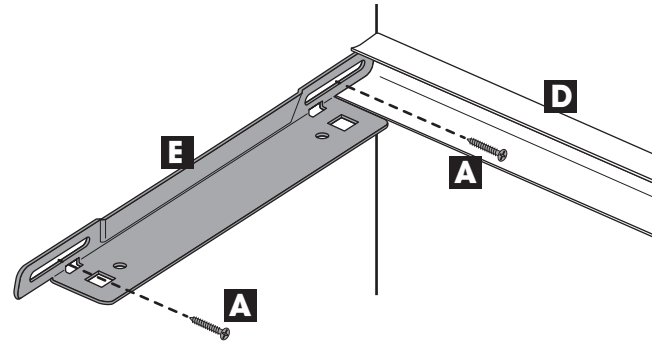

STEP 3

Measure and cut melamine board (K) to at least 1/2" but no more than 1" shorter than width of back wall. Rest melamine board on side brackets (E) and slide backwards into back channel (D). Push in firmly to ensure board makes contact with back surface. Secure board from underside with (2) of screw (B) in each side bracket and where applicable on underside of back channel.

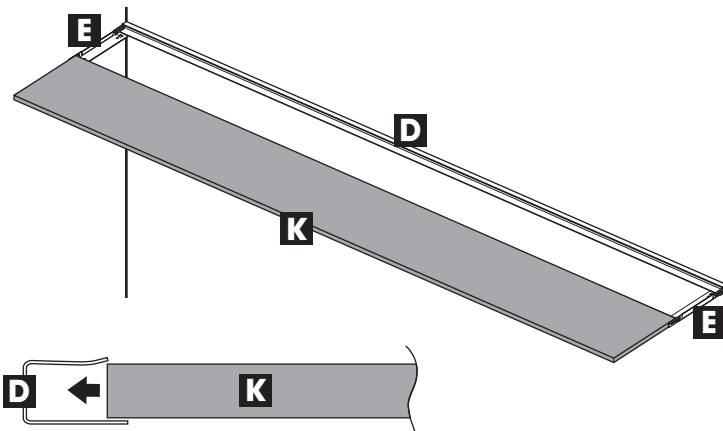

STEP 4

Expand shelf trim over edge of board. Place over edge of melamine board until the front of the trim makes contact with front edge of melamine board. Press firmly from the top and bottom to snap into side bracket (E). Use shelf trim (G) for left side and shelf trim (H) for right side.

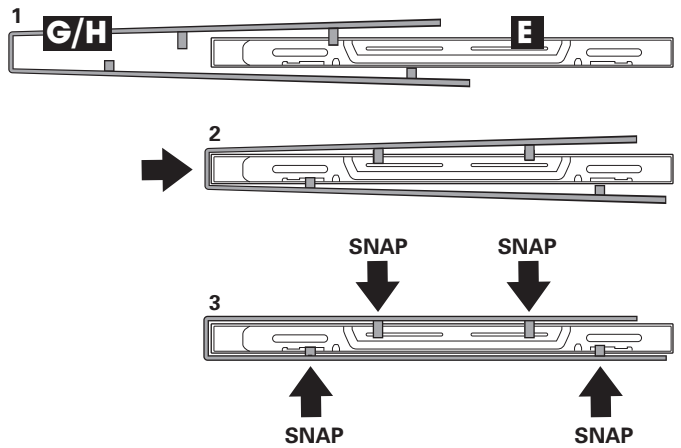

Bottom View

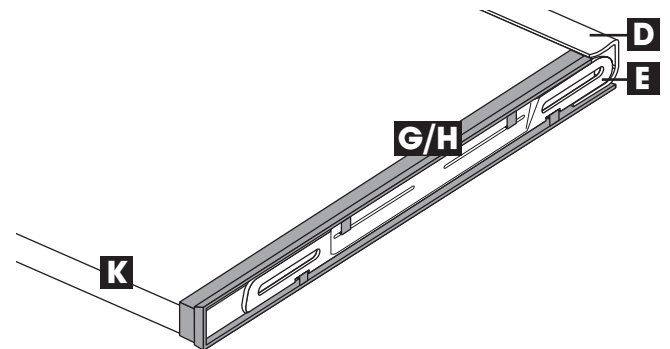
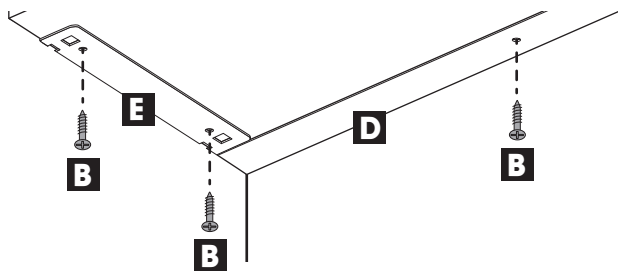

STEP 5

***If installing shelf without pole proceed to Step 6.**

Install pole cup (I) using (2) of screw (A) so that it is in between the locator marks on the shelf trim (G/H). Repeat on both sides of board.

Wall Side View

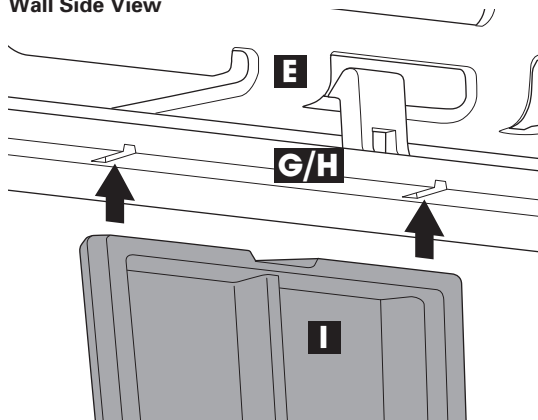

Inside View

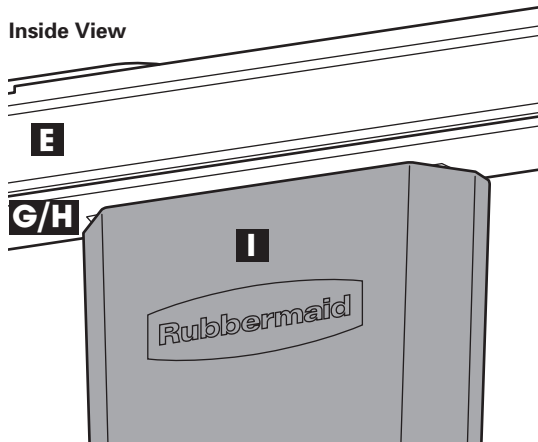

STEP 6

Place angle brackets (F/L) symmetrically under melamine board (K), no more than 32" apart and no more than 16" from each end, into studs. If stud not available use drywall anchor (C) + screw (A) and place no more than 24" apart. If installing hang rod use angle bracket with hook (L). Place level on top of shelf during installation and adjust angle brackets accordingly. Drill keyhole 7" down from bottom of melamine board. Screw in (A) until threads are no longer visible. Place screw in keyhole and press bracket down to engage. Install remaining screws into wall with (A) and into the board with (B).

Front View

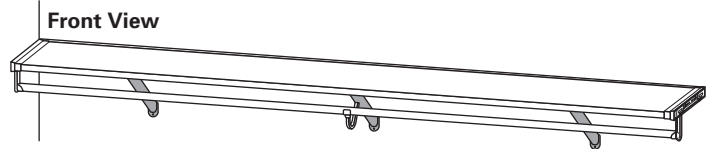

Wall Side View

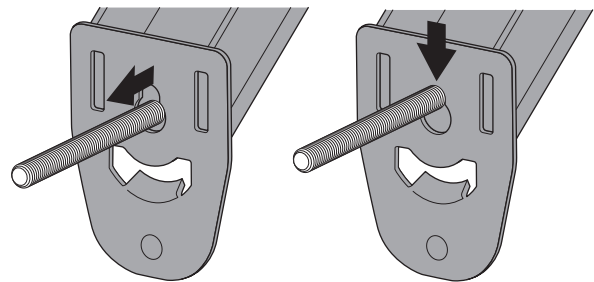

ADDITIONAL INFORMATION

When desired shelf length exceeds 8':

- Use straight H-Channel (N) where end of melamine boards (K) meet to conceal gap

When joining boards in a corner between two walls:

- Use corner H-Channel (M) where melamine boards (K) meet to conceal gap

If using hang rod:

- Combine multiple hang rods (J) using hang rod joiner (P). Insert into both poles and screw until tight
- Corner rounded hang bar (O) should be used when combining pole sections at a corner